

**GCC<sup>®</sup>**

# ***G-Tech Glass System***

Office  
**Office**  
Partition  
**Partition**  
Office  
Partition  
Office  
Partition



**G-2 Fixing Wrench**

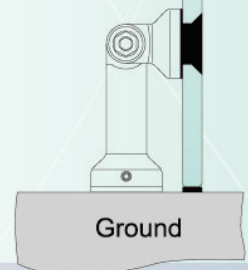

## Glass to Glass - 2 Ways

Angle	Hole Pitch of Connecting Bar		
	52.5	60	82
	Hole Center to Glass Edge		
	A/B	A/B	A/B
90°	75	80	96
95°	70	75	90
100°	66	71	85
105°	62	67	81
110°	59	63	77
115°	55	60	73
120°	52	56	69
125°	49	54	66
130°	47	51	63
135°	44	48	60
180°	25	28.5	39.5

unit:mm

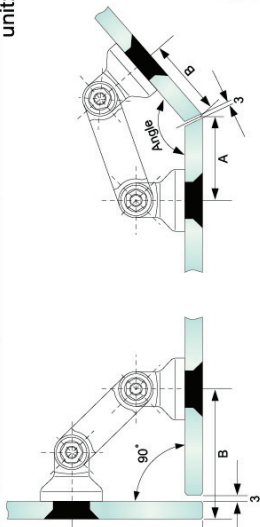

## Glass to Wall

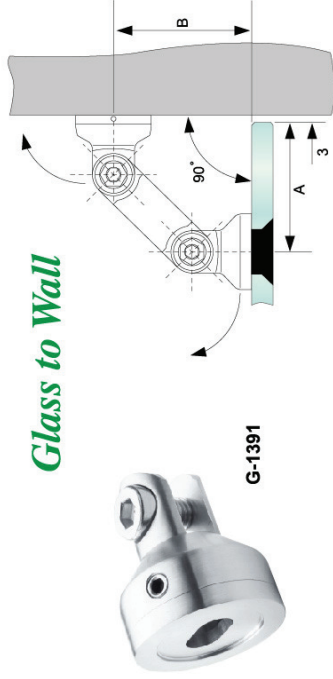

Angle	Hole Pitch of Connecting Bar		
	52.5	60	82
	Hole Center to Glass Edge		
	A	B	B
90°	67	62	72
	A	B	A
	67	62	72
	A	B	B
	67	62	72
	A	B	B
	67	62	72
	A	B	B
	67	62	72

## Glass to Glass - 3 Ways

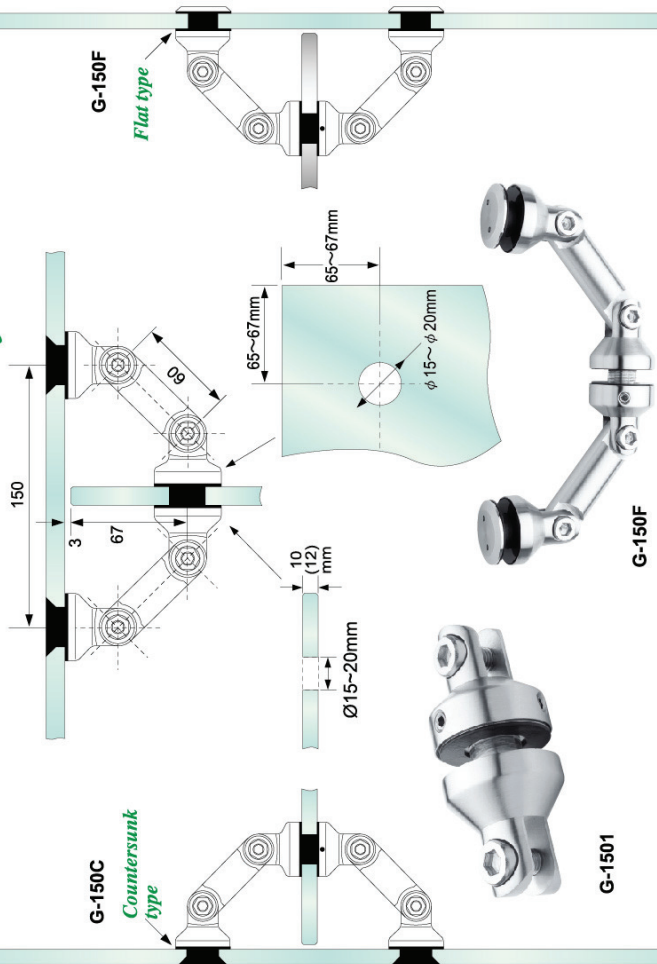

## Glass to Ground / Ceiling

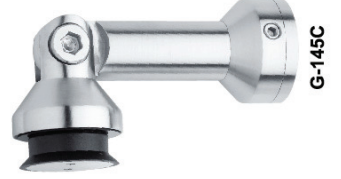
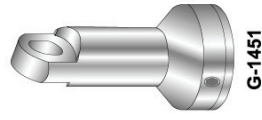

### G-1201C Single Point Fitting

\* Countersunk type

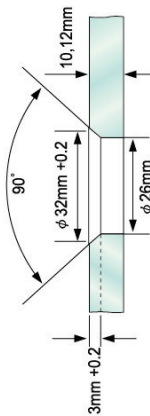

### G-1201F Single Point Fitting

\* Flat type

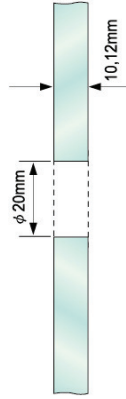

### Single Point Fitting

\* Straight to the Point of glass & wall.  
\* Left & right, up & down and level adjustable to uneven wall.

### G-102C

\* Countersunk type

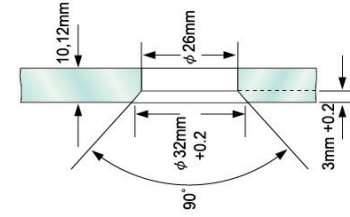

### G-102F

\* Flat type

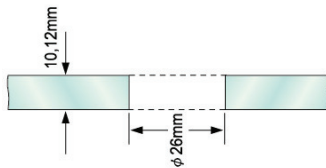

### Single Point Fitting

\* Straight to the Point of glass & wall  
\* Left & right, up & down adjustable.

### Connecting Bar

\* For Connect fitting to glass or to wall.



G-3011

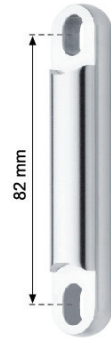

G-3013

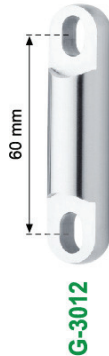

G-3012

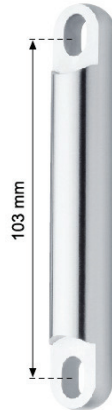

G-3014

### G-102SC

\* Countersunk type

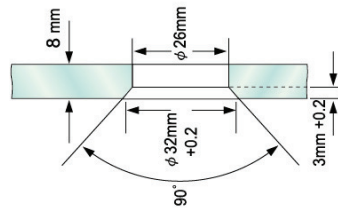

### G-102SF

\* Flat type

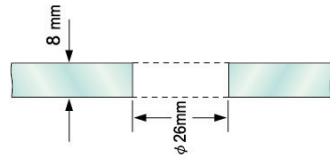

## Adjustable Single Point Fitting

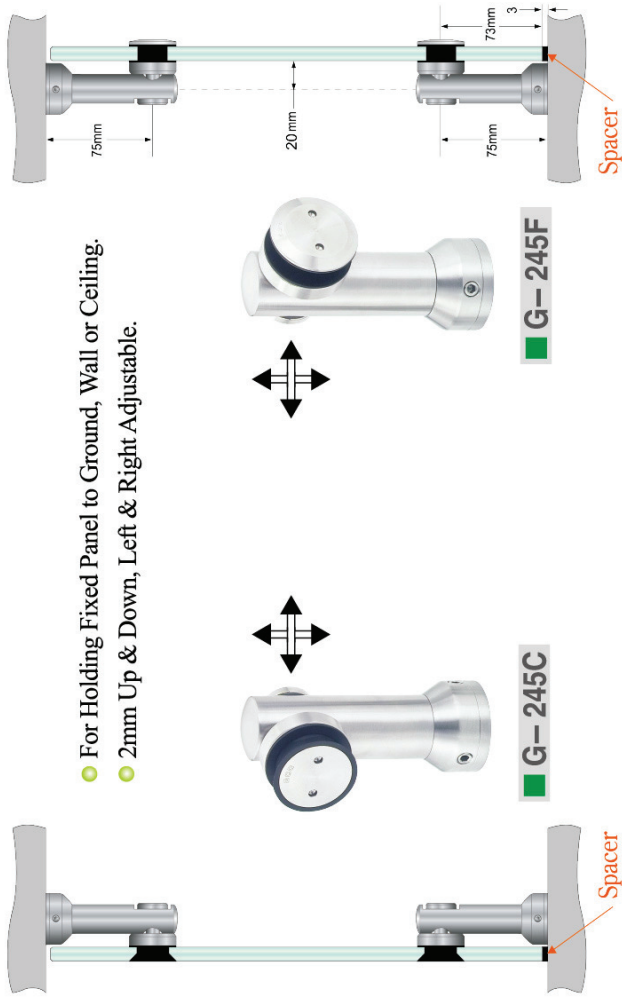

- For Holding Fixed Panel to Ground, Wall or Ceiling.
- 2mm Up & Down, Left & Right Adjustable.

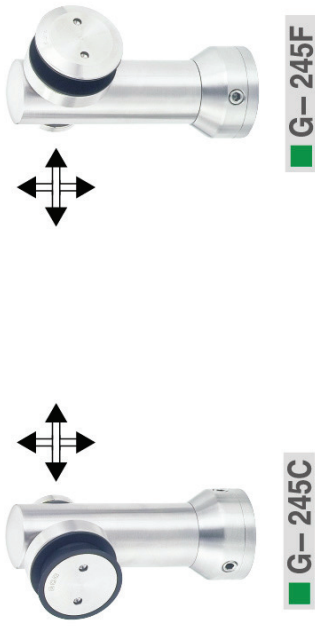

**G-245C**

**G-245F**

## Single Point Fixing

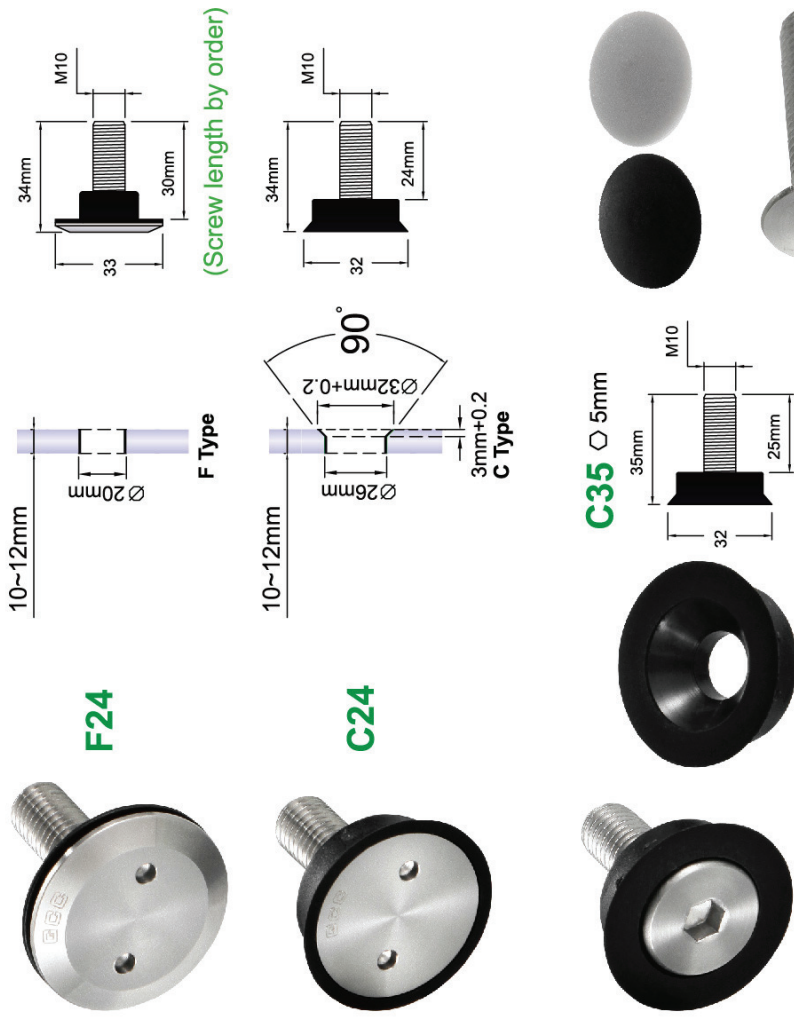

**F24**

**C24**

**C35**  $\varnothing$  5mm

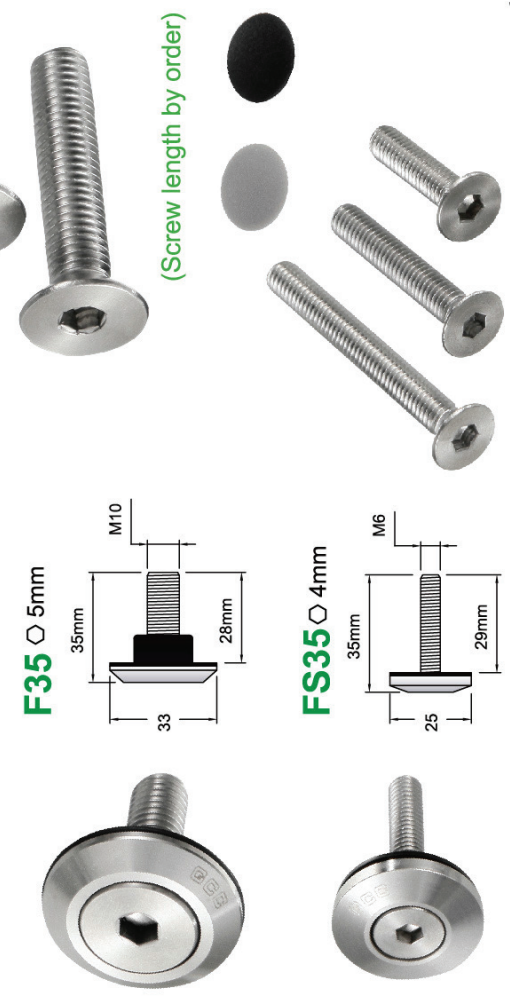

**F35**  $\varnothing$  5mm

**FS35**  $\varnothing$  4mm

## Adjustable Single Point Fitting

### G-102EC

\*Countersunk type

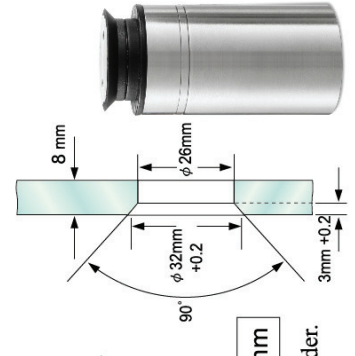

- \* Straight to the Point of glass & wall.
- \* Left & right, up & down and level adjustable to uneven wall.

L (length) 47mm 72mm 97mm

● Special Length Acceptable By Order.

### G-102EF

\*Flat type

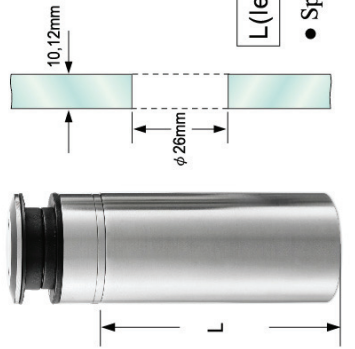



In the field of architectural fittings for glass doors high quality and total design flexibility are essential for ease of installation, safety and functionality.

**GCC** full range of fittings are aesthetically designed and manufactured to provide practicality and security to tempered glass assemblies.

**GCC** will be happy to help your special design requirements, for any doubts, please contact your nearest **GCC** distributors for any technical assistance on parts and services, or contact us directly.

**GCC** reserves all rights to make product modifications or engineering changes without notification.



## GOOD CREDIT CORPORATION

No.13, Longmen Rd., Situn Dist., Taichung 40757, Taiwan

E-mail : [gcctw@ms7.hinet.net](mailto:gcctw@ms7.hinet.net)

Tel : 886 - 4 - 22583755 ( Hunting Line )

Fax : 886 - 4 - 22583753

[http: www.gccintw.com.tw](http://www.gccintw.com.tw)

© Copyright 2008.10 Good Credit Corporation

### Agent / Distributor



Sales  
Finland  
Kuninkaanmäentie 120B  
01260 Vantaa  
+358 40 9008520  
[info@johnberger.fi](mailto:info@johnberger.fi)  
[www.johnberger.fi](http://www.johnberger.fi)

Estonia  
Laki 9A  
10621 Tallinn  
+372 +372 654 6604  
[info@johnberger.ee](mailto:info@johnberger.ee)  
[www.johnberger.ee](http://www.johnberger.ee)