

# Titan.



JOHN BERGER



SCAN WITH YOUR MOBILE  
TO FIND US ONLINE

# Titan.

## MICRO TRACK SYSTEM



red dot design award  
winner 2012



TAIWAN  
EXCELLENCE 2012

### Micro Track System

2314-84253

#### Application

1. Design for boutique, galleries, or other display applications
2. Light up the products by accent lighting

#### User Friendly

1. Lighting can be molded easily without using heavy tools, handling flexible and intuitively
2. The power and mechanical combination, thus decreasing man power
3. Especially flexible during seasonal changes or simple remodeling

#### Safety

Stainable and stable structure

#### Materials

1. LED fixture/ aluminum and easily recycle
2. Micro tracks/ extruded aluminum and anodized finishing
3. Accessories/ sheet metal
4. Shelf/ reinforced glass

# Titan. Your Brightest Choice

# Titan.



■ **U-Shape Micro Track Cabinet Track System**



Cabinet Display



01-04



■ **H-Shape Micro Track Wall Shelf/Display System**



05-10

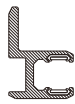

■ **L-Shape Micro Track Free-standing Display System**



11-16



■ **Micro Cabinet Spotlight**

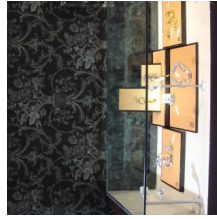

17-20

\*The anodizing black color of Micro Track System is not designed for long-term UV exposure. Please check with your sales contact window for special treatment on Micro Track System.

## Mini Track Kit

- Very easy install, and Plug in-and-out the light head.
- By clever on-off switch, end user can easy change the position of the light head.
- Different set of light heads available on request.
- 3 beam angles of Optical lens provide precise and uniform light effect.
- Two drivers 12W, 8W available for the kit set.



0.45Mx3

### Component List

Type	Item Code	QTY
Track	1. TU-0.45M	3
	2. TU-ECAP	1
Luminaire	3. [1] Micro Track Light(1.5W) TU12-345-501/8	8
	[2] Micro Track Light(1.5W) TU12-345-501/7	7
	[3] Micro Track Light(1.5W) TU12-345-501/6	6
Other	4. TU-T12(AC100-240V, Max 12W)	1
	5. TU-J05(DC12V, Max 6A)	2



■ TU12-345-501/8



0.45Mx2

### Component List

Type	Item Code	QTY
Track	1. TU-0.45M	2
	2. TU-ECAP	1
Luminaire	3. [1] Micro Track Light(1.5W) TU08-245-501/5	5
	[2] Micro Track Light(1.5W) TU08-245-501/4	4
	[3] Micro Track Light(1.5W) TU08-245-501/3	3
Other	4. TU-T08(AC100-240V, Max 8W)	1
	5. TU-J05(DC12V, Max 6A)	1



■ TU08-245-501/5

### U-Shape Micro Track Cabinet Track System

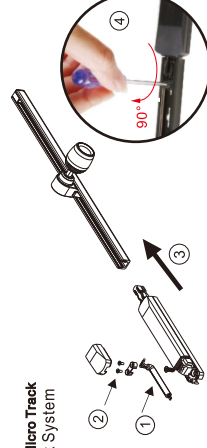

1. Connect AC (100-240V) cable to the transformer.
2. Fix the cable with gasket and screw, then cover the transformer with board.
3. Insert TU-T08 or TU-T12 into U-shape micro track.
4. Screw TU-T08 or TU-T12 into position.



## U-Shape Micro Track

Combination of Cabinet Track System

### U-Shape

TU-0.3M/0.45M/0.6M/0.9M/1M

U-shape micro track:  
Aluminium, anodized

Surface mounted

DC 12V, MAX 6A

L = 300mm; 450mm

600mm; 900mm

1000mm

Color: ■BK



### For U-Shape

#### TU-J01

Straight connector

Plastic

DC 12V, MAX 6A

Color: ■BK

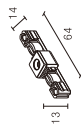

#### TU-J02

L-connector

Plastic

DC 12V, MAX 6A

Color: ■BK

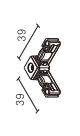

#### TU-J05

Adjustable-connector

plastic

DC 12V, MAX 6A

Color: ■BK

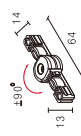

#### TU-L01

Live end

Plastic

DC 12V, MAX 6A

Color: ■BK

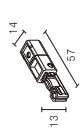

#### TC-L01

Intermediate power connector

Plastic

Coupler for all-type micro track

DC 12V, MAX 6A

Color: ■BK

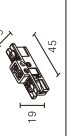

#### TU-ECAP

End cap

Plastic

Color: ■BK

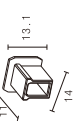

#### TU-F01

Aluminium, anodized

Color: ■BK



JOHN BERGER



## U-Shape

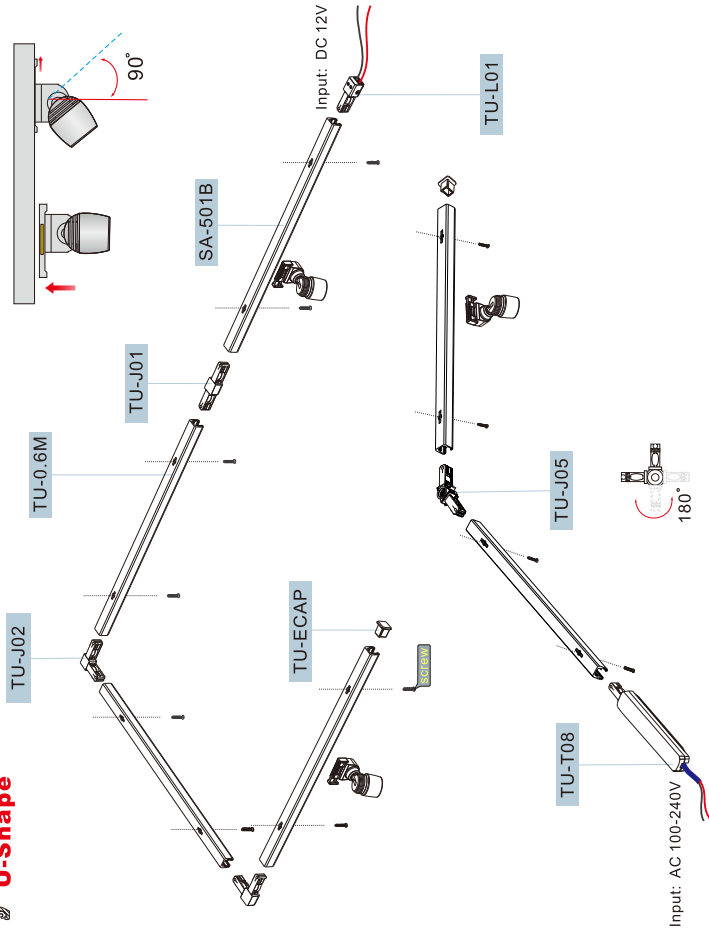

Input: AC 100-240V

Input: DC 12V

Input: DC 12V

Input: DC 12V

Input: DC 12V

## Micro Spotlight

### SA-501A



### SA-501B



### SA-501C



### SA-501D



## Installation manual

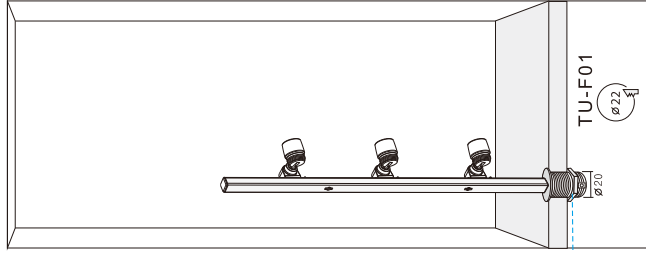
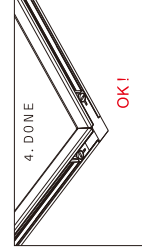
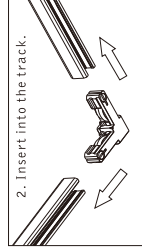
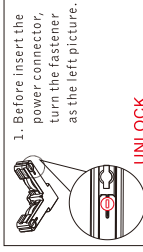

Light head: aluminium, anodized

Adapter: plastic

Input: DC 12V

LED: OSRAM 1.5W(350mA)

3.4W(700mA)

LED color: □ CW □ NW □ WW

Color: ■ BK

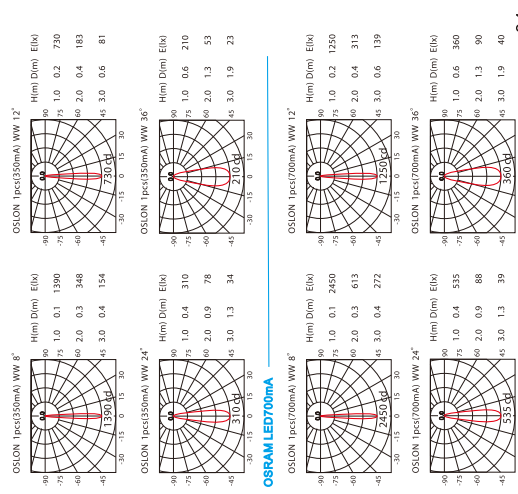

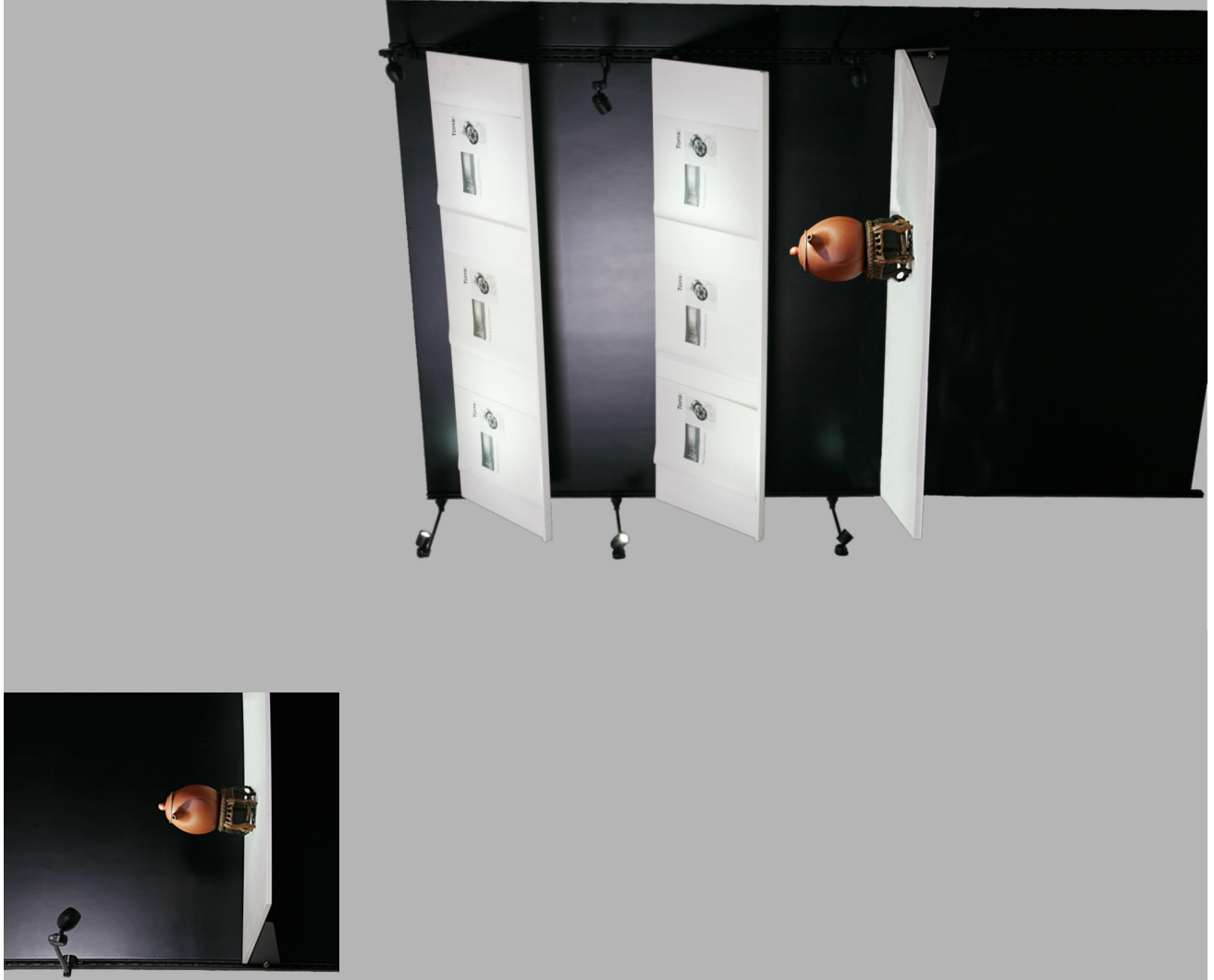

## Installation

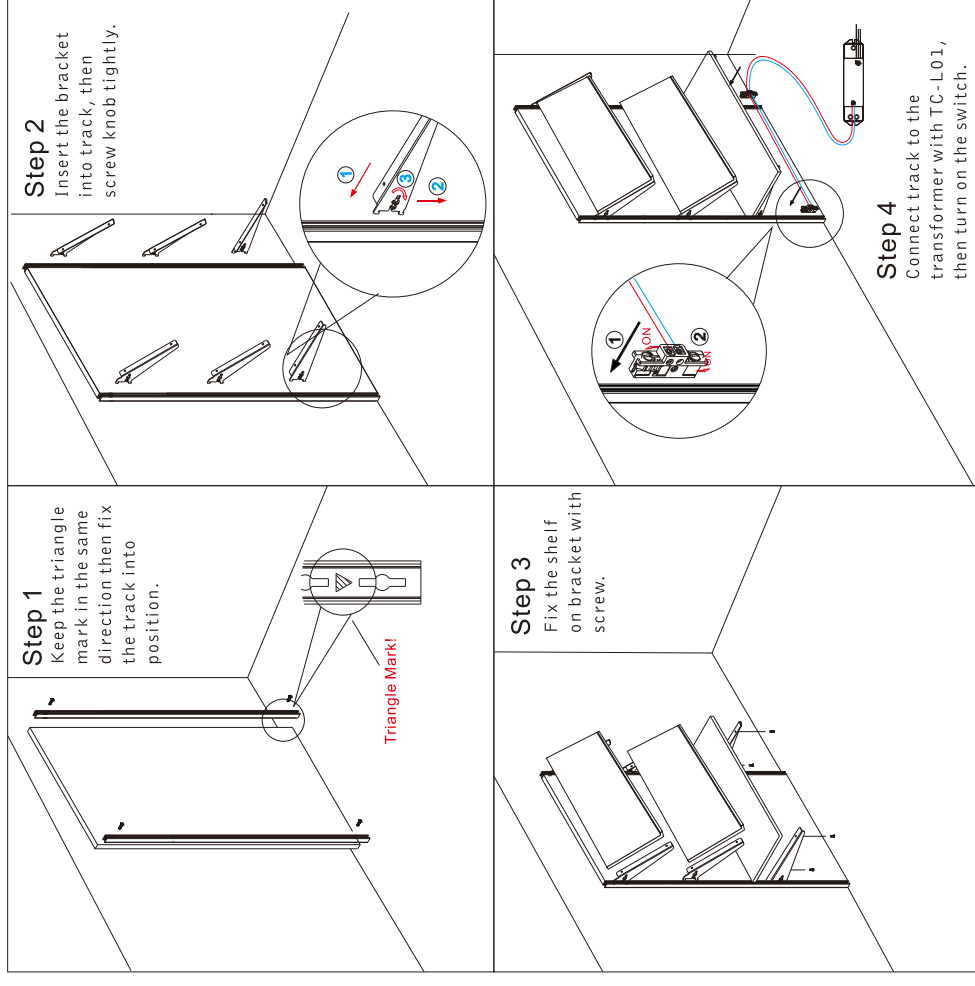

### Component List of Horizontal Bracket Version

Type	Item Code	QTY
Track	1. TH-1.5M	2
	2. AJ-01	2
	3. AJ-02	4
	4. AJ-011	1
	5. AJ-021	2
	6. TC-L01	1
Luminaire	7. TH-ECAP	4
	8. Micro Track Light(1.5W)	6
Other	9. LLV20W12 UNI(AC100-240V)	1

**H-Shape Micro Track System**  
Combination of Wall Shelf Display System

**H-Shape**

TH-0.3M/0.45M/0.6M/0.9M/1M/1.5M

TITAN H-shape micro track:

Aluminium, anodized  
Surface mounted  
DC 12V, MAX 6A  
L = 300mm; 450mm  
600mm; 900mm  
1000mm; 1500mm  
Color: ■BK



**For H&L-Shape**

**TH-J01**

Straight-connector  
Plastic  
DC 12V, MAX 6A  
Color: ■BK



**TH-L01**

Live end  
Plastic  
DC 12V, MAX 6A  
Color: ■BK



**TH-ECAP**

End cap  
plastic  
Color: ■BK

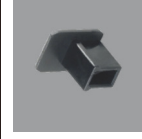

**Horizontal Bracket**

**AJ-01**

Bracket  
Steel, powder-coated  
For H&L-shape micro track  
Color: ■BK



**Tilted Bracket**

**AJ-02**

Bracket  
Steel, powder-coated  
For H&L-shape micro track  
Color: ■BK



**TC-L01**

Intermediate power connector  
Plastic  
Coupler for all-type micro track  
DC 12V, MAX 6A  
Color: ■BK



**Micro Spotlight**

Light head: aluminium, anodized  
Stick: copper, powder-coated.  
Adapter: plastic  
Input: DC 12V  
LED: OSRAM  
LED color: □CW □NW □WW  
Color: ■BK



**1.5W(350mA) or 3.4W(700mA)**

SA-511A	SA-511B	SA-511C	SA-511D
OSLON 1pc(s350ma) WW 8°	OSLON 1pc(s350ma) WW 12°	OSLON 1pc(s350ma) WW 36°	OSLON 1pc(s350ma) WW 36°
Beam diagram showing 8° beam angle	Beam diagram showing 12° beam angle	Beam diagram showing 36° beam angle	Beam diagram showing 36° beam angle
Beam diagram showing 8° beam angle	Beam diagram showing 12° beam angle	Beam diagram showing 36° beam angle	Beam diagram showing 36° beam angle

**3W(350mA)**

SA-512A	SA-512B	SA-512C	SA-512D
OSLON 1pc(s350ma) WW 8°	OSLON 1pc(s700ma) WW 12°	OSLON 1pc(s700ma) WW 36°	OSLON 1pc(s700ma) WW 36°
Beam diagram showing 8° beam angle	Beam diagram showing 12° beam angle	Beam diagram showing 36° beam angle	Beam diagram showing 36° beam angle
Beam diagram showing 8° beam angle	Beam diagram showing 12° beam angle	Beam diagram showing 36° beam angle	Beam diagram showing 36° beam angle

**Horizontal Board**

AJ-011  
L:1000mm  
W:300mm  
H:9mm

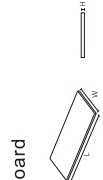

**Tilted Board**

AJ-021  
L:1000mm  
W:300mm  
H:16mm



**H-Shape**

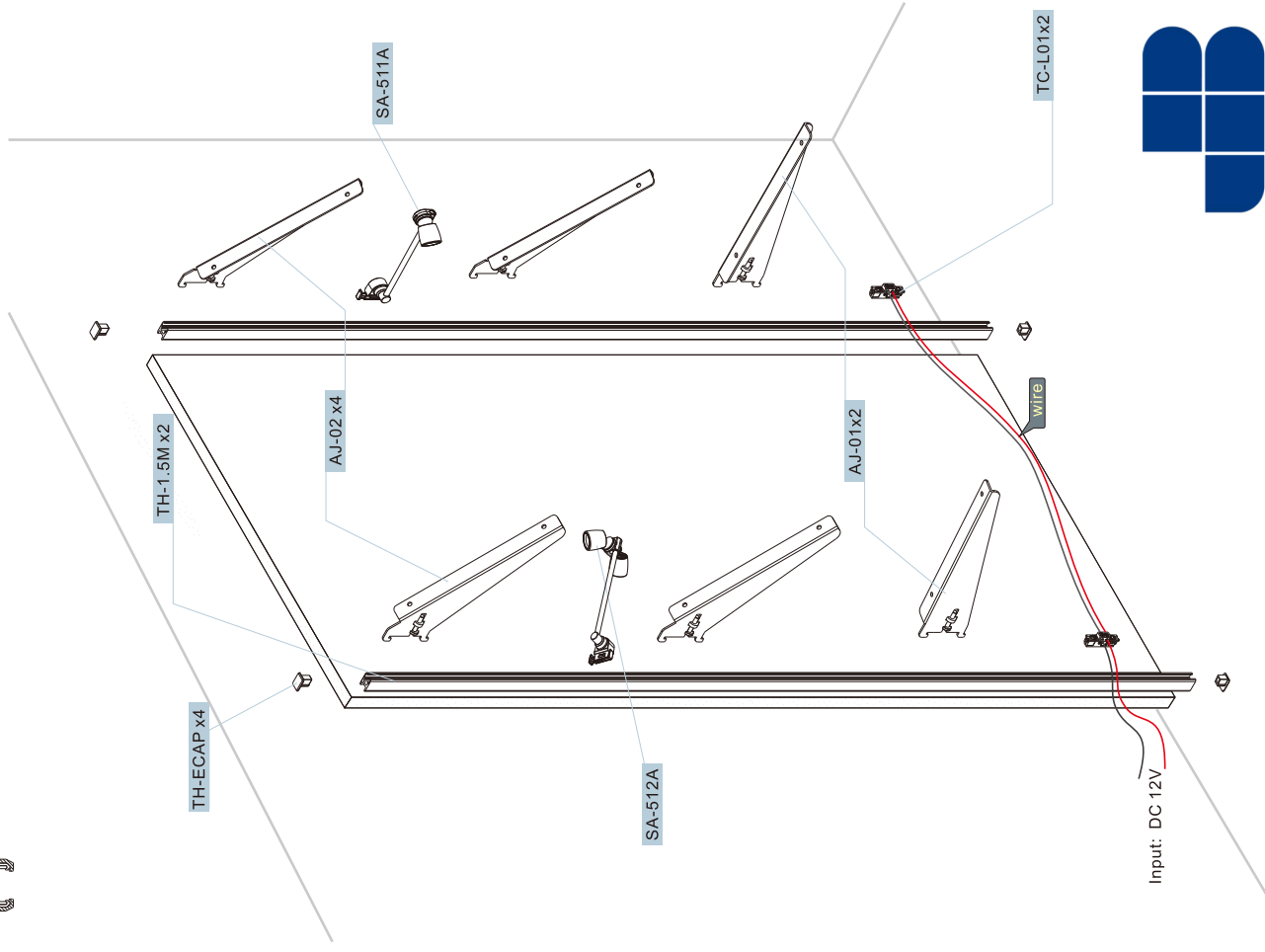

# Drivers & Accessories

## Constant Voltage Driver

- Terminal block (screw)
- Quick connector
- Push quick connector

Available for 1.5W (350mA)LED

3W (350mA)LED

1.5W (350mA)LED



Driving Fixture QTY

LMV12W12 UNI	<input type="checkbox"/>	4	or	8
Input: AC100-240V				
Po: MAX 12W				
Vo: DC 12V, MAX 1000mA				
L:85 W:40 H:22				



Driving Fixture QTY

LLV20W12 UNI	<input type="checkbox"/>	6	or	12
Input: AC100-240V				
Po: MAX 20W				
Vo: DC 12V, MAX 1670mA				
L:167 W:38.4 H:30				



Driving Fixture QTY

LHV60W12	<input type="checkbox"/>	20	or	37
Input: AC220-240V				
Po: MAX 60W				
Vo: DC 12V, MAX 5000mA				
L:190.5 W:88 H:35.5				



Available for 3.4W(700mA) LED

Driving Fixture QTY

LMV12W12 UNI	<input type="checkbox"/>	3
Input: AC100-240V		
Po: MAX 12W		
Vo: DC 12V, MAX 1000mA		
L:85 W:40 H:22		



Driving Fixture QTY

LLV20W12 UNI	<input type="checkbox"/>	5
Input: AC100-240V		
Po: MAX 20W		
Vo: DC 12V, MAX 1670mA		
L:167 W:38.4 H:30		



Driving Fixture QTY

LHV60W12	<input type="checkbox"/>	17
Input: AC220-240V		
Po: MAX 60W		
Vo: DC 12V, MAX 5000mA		
L:190.5 W:88 H:35.5		



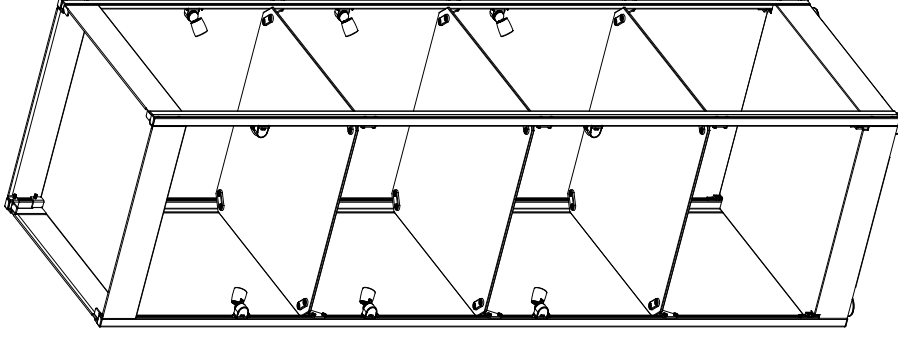

**Component List**

Type	Item Code	QTY
Track	1. TL-1.8M	4
	2. AJ-05(L)	6
	3. AJ-05(R)	6
	4. TH-ECAP	4
Luminaire	5. Micro Track Light(1.5W)	12
Other	6. AJ-05A	1
	7. AJ-05B (with LLV20W12 UNI)	1
	8. AJ-05C	3





**L-Shape**

TL-0.6M/0.9M/1M/1.2M/1.5M/1.8M

L-shape micro track:

Aluminium, anodized  
Combination or Surface mounted  
DC 12V, MAX. 6A  
L=600mm; 900mm; 1000mm;  
L=1200mm; 1500mm; 1800mm  
Color: ■BK

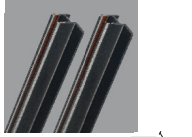

**For L-Shape**

AJ-05(L & R)

Steel, powder-coated,  
with screw kit & PC gasket.

Color: ■BK



**TC-L01**

Intermediate power connector

Plastic  
Coupler for all-type micro track  
DC 12V, MAX. 6A  
Color: ■BK



**TH-ECAP**

End cap  
plastic

Color: ■BK



**AJ-05A**

Steel, powder-coated.

Color: ■BK

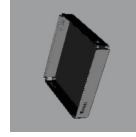

**AJ-05C**

Safety glass  
(Clear glass)

L:450 W:450 H:5



**AJ-04B / AJ-05B / AJ-06B**

Steel, powder-coated, with plug.

Color: ■BK

Includes:

TH-ECAP x 4  
TC-L01 x 4  
AJ-05D x 4  
Screw x 8

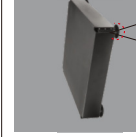

**Transformer x 1**

Base Type	Transformer Type	Input	Output
AJ-04B	LV18W12 (UNI)	AC 100-240V	DC 12V 12W
AJ-05B	LV18W12 (UNI)	AC 100-240V	DC 12V 25W
AJ-06B	LV18W12 (UNI)	AC 220-240V	DC 12V 65W

**Micro Bar**

LV-L05A  
LV-L05B

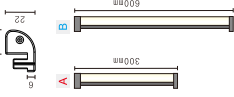

Housing: aluminium, anodized, 25° tilt

Adapter: plastic

For H & L-shape micro track

Input: DC 12V

LED: 2W 18PCS 300mm (LV-L05A)

4W 39PCS 600mm (LV-L05B)

Color: ■BK



LV-L05A 18pcs WW 110°

LV-L05B 39pcs WW 110°

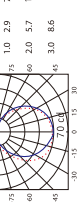

C-90-270  
C0-180

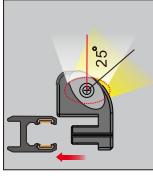

\* U & L Shape only

**Micro Spotlight**

SA-501A



SA-501B



SA-501C



SA-501D

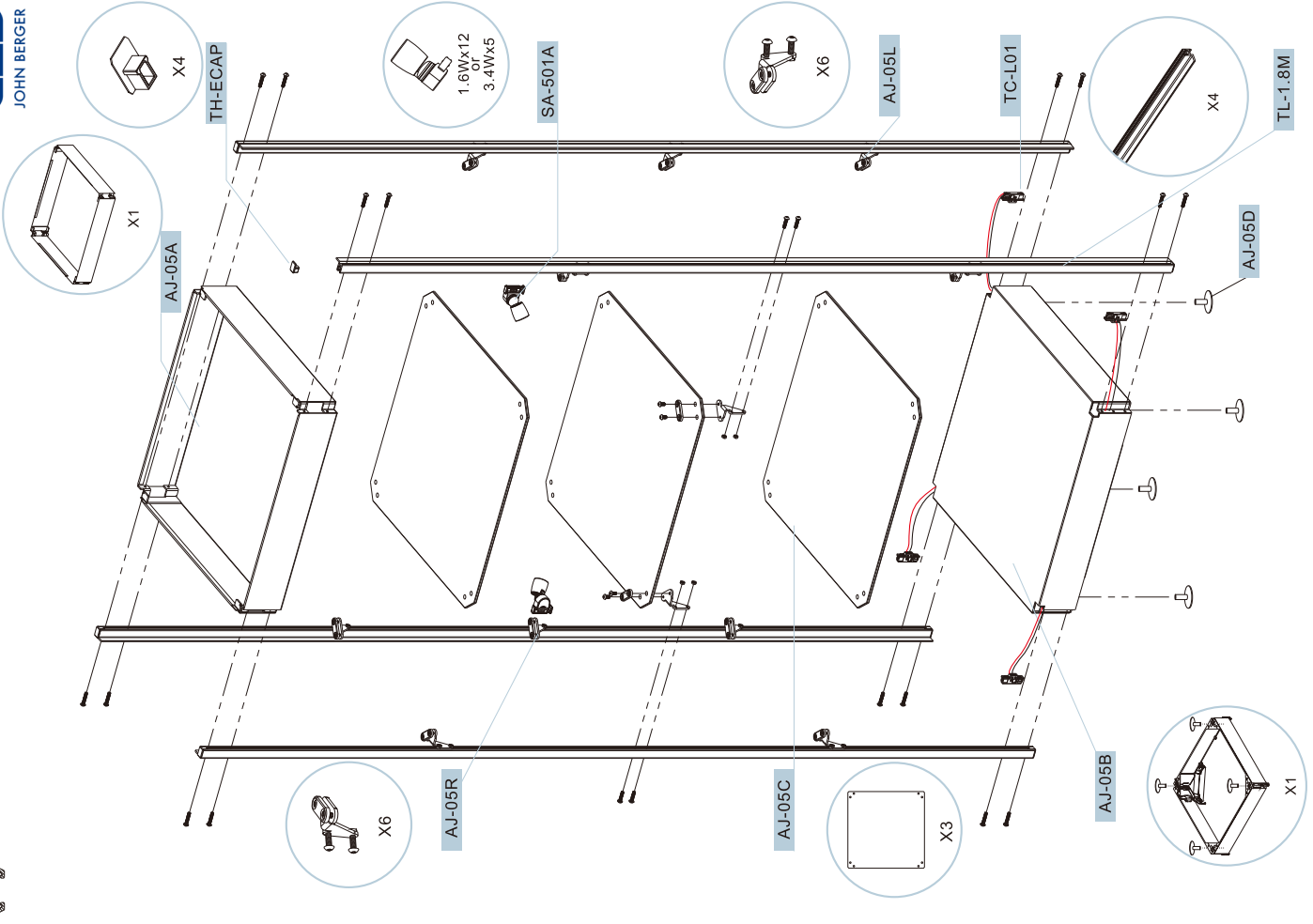

## Installation

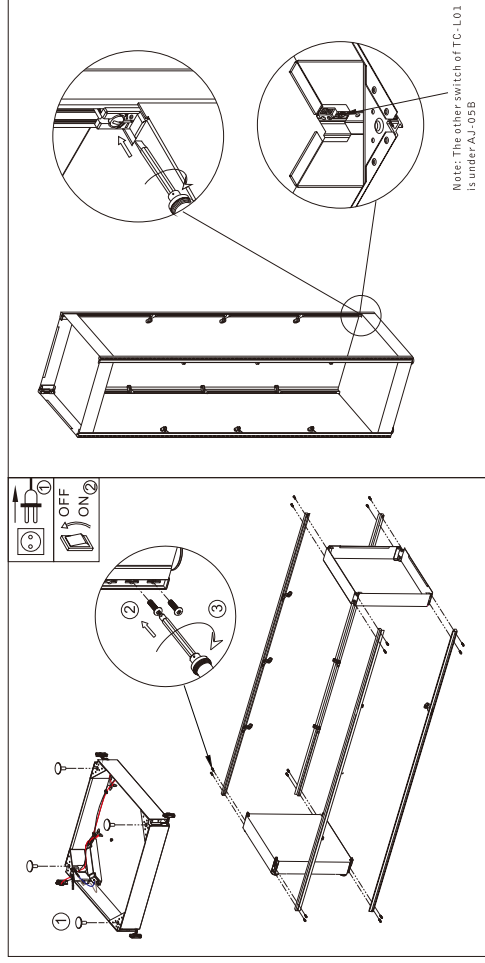

Step 1

Step 2

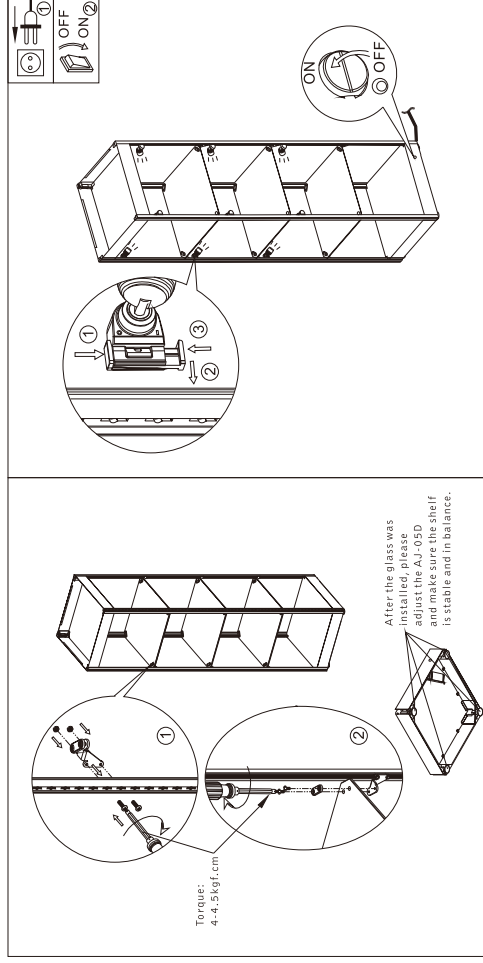

Step 3

Step 4

## Drivers & Accessories

### Constant Voltage Driver & optional component

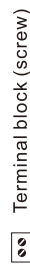

Terminal block (screw)



Quick connector



Push quick connector



1.5W

Micro Spotlight



2W

Micro Bar 300mm



3.4W

Micro Spotlight



LMV12W12 UNI

Input: AC100-240V

Po: MAX 12W

Vo: DC 12V, MAX 1000mA

L:85 W:40 H:22

Driving Fixture QTY

8	0	0
5	2	0
3	0	2
:	A	B
12W ≥	1.5W x A	2W x B
	+	+
		3.4W x C



LLV20W12 UNI

Input: AC100-240V

Po: MAX 20W

Vo: DC 12V, MAX 1670mA

L:167 W:38.4 H:30

Driving Fixture QTY

13	0	0
8	4	0
5	6	0
0	3	4
0	1	5
:	A	B
20W ≥	1.5W x A	2W x B
	+	+
		3.4W x C



LHV60W12

Input: AC220-240V

Po: MAX 60W

Vo: DC 12V, MAX 5000mA

L:190.5 W:88 H:35.5

Driving Fixture QTY

40	0	0
0	30	0
0	0	17
0	11	11
17	17	0
:	A	B
60W ≥	1.5W x A	2W x B
	+	+
		3.4W x C

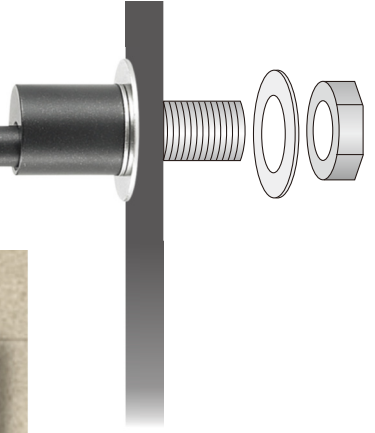

LA-501A



LA-501B



LA-501C



LA-501D



Light head: aluminum, anodized  
 Stick: copper, powder-coated.  
 LED: OSRAM 1.2W or 3W  
 LED color: □ CW □ NW □ WW  
 Color: ■ BK

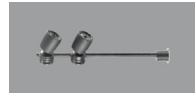
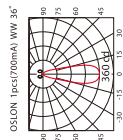
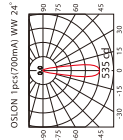
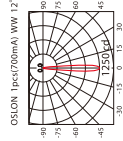
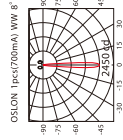

LA-502A



LA-502B



LA-502C



LA-502D



Light head: aluminum, anodized  
 Stick: copper, powder-coated.  
 LED: OSRAM 1.2Wx2 or 3Wx2  
 LED color: □ CW □ NW □ WW  
 Color: ■ BK

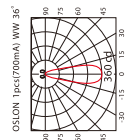
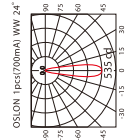
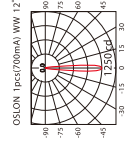
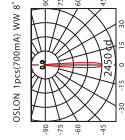





## Constant Current Driver

-  Terminal block (screw)
  Quick connector
  Push quick connector





Available for (350mA) LED

Driving Fixture QTY	3W x 2	1.2W x 1
	1	1-3
<b>LSVC3AI-Z UNI</b> Input:100-240V output: 1-10.3V 350mA L:55 W:40 H:20	<b>or</b>	<b>or</b>
	1-2	2-4
<b>LFVC4AI-Z UNI</b> Input:100-240V output: 3-14V 350mA L:73 W:40 H:16	<b>or</b>	<b>or</b>
	4	7-9
<b>LMC10W350-Z</b> Input:220-240V output: 17-29V 350mA L: 85 W: 40. 4 H: 22	<b>or</b>	<b>or</b>
	5-6	10-13
<b>LMC15W350-Z</b> Input:220-240V output: 26-43V 350mA L: 85 W: 40. 4 H: 22	<b>or</b>	<b>or</b>
	7-8	13-17
<b>LBC20W350-Z</b> Input:120-277V output: 36-55.7V 350mA L: 116.4 W: 44 H: 30	<b>or</b>	<b>or</b>

## Accessories

Available for constant current 350mA

	<b>LDL-AC2</b> Multi-lamp extension cord 1007#22awg L:1000/1500/2000/3000		<b>LDL-AC2-3</b> Multi-lamp extension cord 1007#22awg L:1000/1500/2000/3000		<b>LDL-AC2-6</b> Multi-lamp extension cord 1007#22awg L:1000/1500/2000/3000
---	--	---	--	---	--

Available for (700mA) LED



Driving Fixture QTY	3W x 2	3W x 1
	x	1
<b>LVC3BI-Z UNI</b> Input:100-240V output: 2-5V 700mA L:55 W:39 H:20	<b>or</b>	<b>or</b>
	1	2
<b>LSC6W700-Z</b> Input:100-240V output: 3-9V 700mA L: 66.3 W: 38. 5 H: 22	<b>or</b>	<b>or</b>
	2	3-4
<b>LMC10W700-Z</b> Input:220-240V output: 8.5-14V 700mA L: 85 W: 40. 4 H: 22	<b>or</b>	<b>or</b>
	3	5-6
<b>LMC15W700-Z</b> Input:220-240V output: 13-21V 700mA L: 85 W: 40. 4 H: 22	<b>or</b>	<b>or</b>
	3-4	7-8
<b>LBC20W700-Z</b> Input:120-277V output: 18-28V 700mA L: 116.4 W: 44 H: 30	<b>or</b>	<b>or</b>

## Accessories

Available for constant current 700mA

	<b>LDL-AC2B</b> Multi-lamp extension cord 1007#22awg L:1000/1500/2000/3000		<b>LDL-AC2-3B</b> Multi-lamp extension cord 1007#22awg L:1000/1500/2000/3000		<b>LDL-AC2-6B</b> Multi-lamp extension cord 1007#22awg L:1000/1500/2000/3000
--	---	---	---	---	---